

High Frequency Units – The Basics

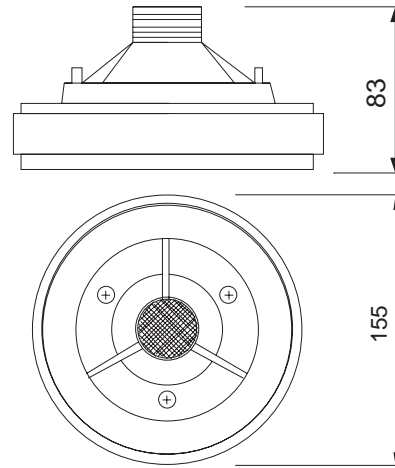

HF100



CD125

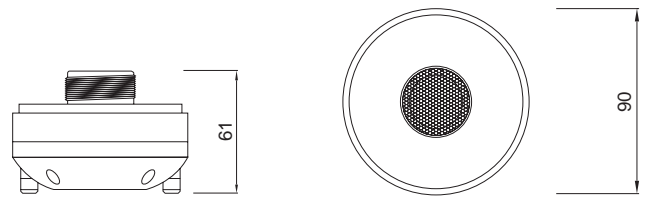

HF250

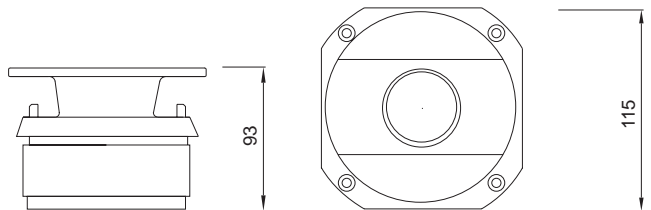
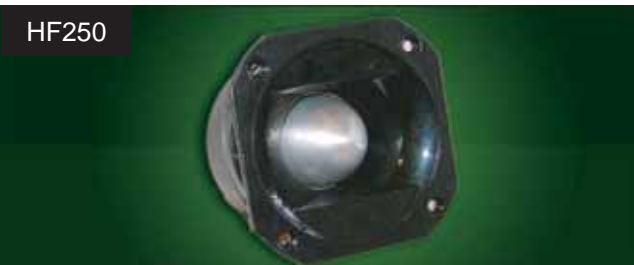

ST5020

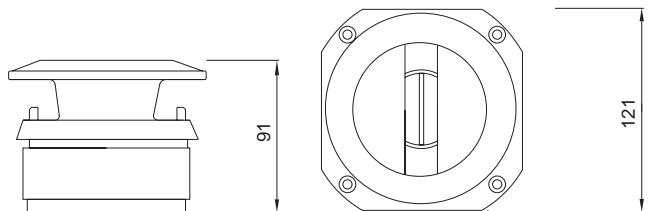

ST5022

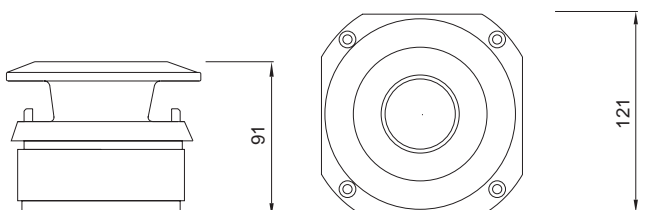
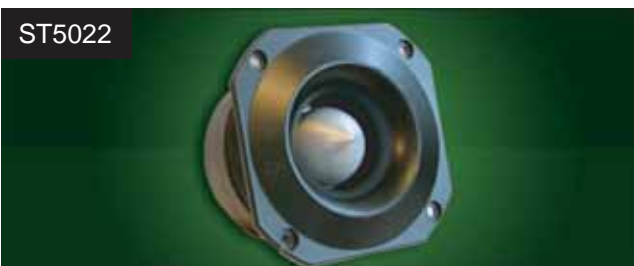

In 5 decades of manufacturing it is not unusual to notice that certain products find a unique niche, whether because of their particular audio characteristics, their cost/performance ratio, or that they are simply a “bulletproof” solution to a particular application. Four of the units illustrated each have one or more of these useful features, and over the years they have delivered satisfaction to so many customers that we keep these in continual manufacture.

Supported by our replacement diaphragm policy, these units still make a valuable contribution to Fanes long industrial history of delivering what customers want. Despite cosmetic changes over the years, we have no need to attempt to disguise their ancient and rugged origins!

The CD125 screw-in compression driver is a 2005 introduction to the Basics range, delivering a cost-effective solution for budget systems.

Electro mechanical specifications

	HF100	CD125	HF250	ST5020	ST5022
Sound channel/throat (inches/mm)	1"/25mm	1"/25mm			
Nominal Impedance (ohms)	8Ω/16Ω	8Ω	8Ω	8Ω	8Ω
Power handling (watts AES)	100W	25W	50W	40W	40W
Average Sensitivity 1W/1m(dB)	104dB	104dB	105dB	110dB	112dB
Usable Frequency range – kHz	1.kHz-15.kHz	1.2kHz-18.kHz	5.kHz-20.kHz	6.kHz-21kHz	6.kHz-21kHz
Recommended crossover frequency at 18dB/Oct.	1.2kHz	1.2kHz	5.kHz	6.kHz	6.kHz
Voice coil diameter (inch/mm)	2"/51mm	1.375"/34.4mm	2"/51mm	1¼"/44mm	1¼"/44mm
Flux density (Tesla)	1.8	1.25	1.64	1.8	1.8
Magnet weight (oz/kg)	50/1.4	10oz/0.28kg	32/.92	32/.92	32/.92
Polar response	n/a	n/a	5kHz-90°H/65°V 10kHz-90°H/36°V 15kHz-28°H/26°V	5kHz-120°H/50°V 10kHz-150°H/40°V 15kHz-110°H40°V	5kHz-90°Conical 10kHz-42°Conical 15kHz-30°Conical

Construction Materials

	HF100	CD125	HF250	ST5020	ST5022
Coil former	Glassfibre	Kapton	Glassfibre	Polyimide	Polyimide
Voice coil material	Copper	Copper	Copper	Copper	Copper
Diaphragm material	Phenolic	Titanium	Aluminium	Aluminium	Aluminium
Magnet Material	Ferrite	Ferrite	Ferrite	Ferrite	Ferrite
Polarity (for all models)	Positive voltage at red/+ terminal causes positive pressure at throat exit				

Mounting Information

	HF100	CD125	HF250	ST5020	ST5022
Screw dimensions (HF100 & CD125)	1½" x 18TPI screw-in	1½" x 18TPI screw-in	n/a	n/a	n/a
Bolt fixing holes	n/a	n/a	4 x M5	4 x M5	4 x M5
Mounting pitch circle diameter	n/a	n/a	4½"/117.5mm	5"/127mm	5"/127mm
Cut-out dia. - front mounted	n/a	n/a	4.1"/104mm	4.2"/106mm	4.2"/106mm
Magnet diameter (inch/mm)	6.125"/155mm	3.5"/90mm	5.05"/103mm	5.05"/103mm	5.05"/103mm
Overall depth (inch/mm)	3.25"/83mm	2.40"/61mm	3.7"/93mm	3.6"/91mm	3.6"/91mm
Depth - from rear of flange (inch/mm)	n/a	n/a	3.5"/88mm	3.15"/80mm	3.15"/80mm
Net weight (kg)	3.88	0.914	3.02	2.65	2.61
Shipping weight(kg)	3.94	0.98	3.14	2.76	2.72
Packing carton dimensions (mm)	165x180x100	100x100x75	140x150x115	140x150x115	140x150x115
Packing carton dimensions (inch)	6.5"x7"x4"	4"x4"x3"	5.5"x6"x4.5"	5.5"x6"x4.5"	5.5"x6"x4.5"

